

Aquam5S/Aquam8S/Aquam9S Series Industrial Ethernet Switches Hardware Installation Manual

Publication Date: Jul. 2021

Version: V1.3

No.: 112023082

KYLAND

Aquam5S/Aquam8S/Aquam9S Series Industrial Ethernet Switches

Hardware Installation Manual

Disclaimer: Kyland Technology Co., Ltd. tries to keep the content of this manual as accurate and as updated as possible. This document is not guaranteed to be error-free, and we reserve the right to amend it without notice to users.

All rights reserved. No part of this documentation may be excerpted, reproduced, translated, annotated or duplicated, in any form or by any means without the prior written permission of KYLAND Corporation.

Copyright © 2018 Kyland Technology Co., Ltd.

Notice for Safety Operation

The product performs reliably as long as it is used according to the guidance. Artificial damage or destruction of the device should be avoided. Before using the device, read this manual carefully for personal and equipment safety. Please keep the manual for further reference. Kyland is not liable to any personal or equipment damage caused by violation of this notice.

- Do not place the device near water sources or damp areas. Keep the ambient relative humidity within the range from 5% to 95% (non-condensing). Be suitable for indoor use only.
- Do not place the device in an environment with high magnetic field, strong shock, or high temperature. Keep the working and storage temperatures within the allowed range.
- Install and place the device securely and firmly.
- Please keep the device clean; if necessary, wipe it with a soft cotton cloth.
- Do not place any irrelevant materials on the device or cables. Ensure adequate heat dissipation and tidy cable layout without knots.
- Wear antistatic gloves or take other protective measures when operating the device.
- Avoid any exposed metal wires because they may be oxidized or electrified.
- Install the device in accordance with related national and local regulations.
- Before power-on, make sure the power supply is within the allowed range of the device. High voltage may damage the device.
- Power connectors and other connectors should be firmly interconnected.
- Do not plug in or out the power supply with wet hands. When the device is powered on, do not touch the device or any parts with wet hands.
- Before operating a device connected to a power cable, remove all jewelry (such as rings, bracelets, watches, and necklaces) or any other metal objects, because they may cause electric shock or burns.
- Do not operate the device or connect or disconnect cables during an electrical storm.
- Use compatible connectors and cables. If you are not sure, contact our sales or

technical support personnel for confirmation.

- Do not disassemble the device by yourself. When an anomaly occurs, contact our sales or technical support personnel.
- If any part is lost, contact our sales or technical support personnel to purchase the substitute. Do not purchase parts from other channels.
- Dispose of the device in accordance with relevant national provisions, preventing environmental pollution.

In the following cases, please immediately shut down your power supply and contact your Kyland representative:

- Water gets into the equipment.
- Equipment damage or shell damage.
- Equipment operation or performance has abnormally changed.
- The equipment emits odor, smoke or abnormal noise.

NOTE: This equipment has been tested and found to comply with the limits for a Class A digital device, pursuant to part 15 of the FCC Rules. These limits are designed to provide reasonable protection against harmful interference when the equipment is operated in a commercial environment. This equipment generates, uses, and can radiate radio frequency energy and, if not installed and used in accordance with the instruction manual, may cause harmful interference to radio communications. Operation of this equipment in a residential area is likely to cause harmful interference in which case the user will be required to correct the interference at his own expense.

Contents

1	Product Overview	1
2	Structure and Interface	2
3	Mounting.....	5
3.1	Dimension Drawing	5
3.2	Mounting Modes and Steps	5
4	Connection	8
4.1	10/100Base-T(X) Ethernet Port.....	8
4.1.1	Functions	8
4.1.2	Pin Definitions and Wiring Sequence.....	8
4.2	10/100/1000Base-T(X) Ethernet Port.....	11
4.3	Grounding	13
4.4	Power port.....	14
5	LEDs	16
6	Basic Features and Specifications	17

1 Product Overview

Aquam5S/Aquam8S/Aquam9S includes a series of high-performance industrial Ethernet switches developed by Kyland. The series devices are applicable to the industrial field of various harsh environment with strict requirements on reliability due to the solid closed housing, fanless but heat dissipation-capable single-rib shaped chassis, overcurrent, overvoltage for power input, sound EMC protection of M12 ports, and IP65 protection class. All the devices meet the requirements stipulated in the EN50155, EN50121, EN55022 Class A&B and FCC CFR47 Part 15 industrial standards.

The switches support panel mounting. They provide up to one 10/100/1000BASE-T(X) M12 Ethernet ports, eight 10/100Base-T(X) M12 POE Ethernet ports. The 10/100Base-T(X) Ethernet ports support IEEE802.3at (compatible with IEEE802.3af) POE output. The entire PSE is capable of providing a Maximum of 80W feed.

Table 1 Models

Model	Aquam5S-5P-WV-WV、 Aquam8S-8P-WV-WV、 Aquam9S-1GE8P-WV-WV	
Remarks	Protection rating	IP65
	Ports	5P: five 10/100Base-T(X) M12 POE Ethernet ports; 8P: eight 10/100Base-T(X) M12 POE Ethernet ports; 1GE8P:one 10/100/1000BASE-T(X) M12 Ethernet ports , eight 10/100Base-T(X) M12 POE Ethernet ports;
	Power input	WV-WV(24-110VDC(16.8-154VDC), redundant power input)



Note:

We reserve the right to amend the product information listed in this table without notice. To obtain the latest information, you can contact our sales or technical support personnel.

2 Structure and Interface



Caution:

- It is recommended to purchase the port dustproof shield (optional) to keep ports clean and ensure switch performance.
- If the equipment is used in a manner not specified by the manufacturer, the protection provided by the equipment may be impaired.

- Aquam5S Front Panel

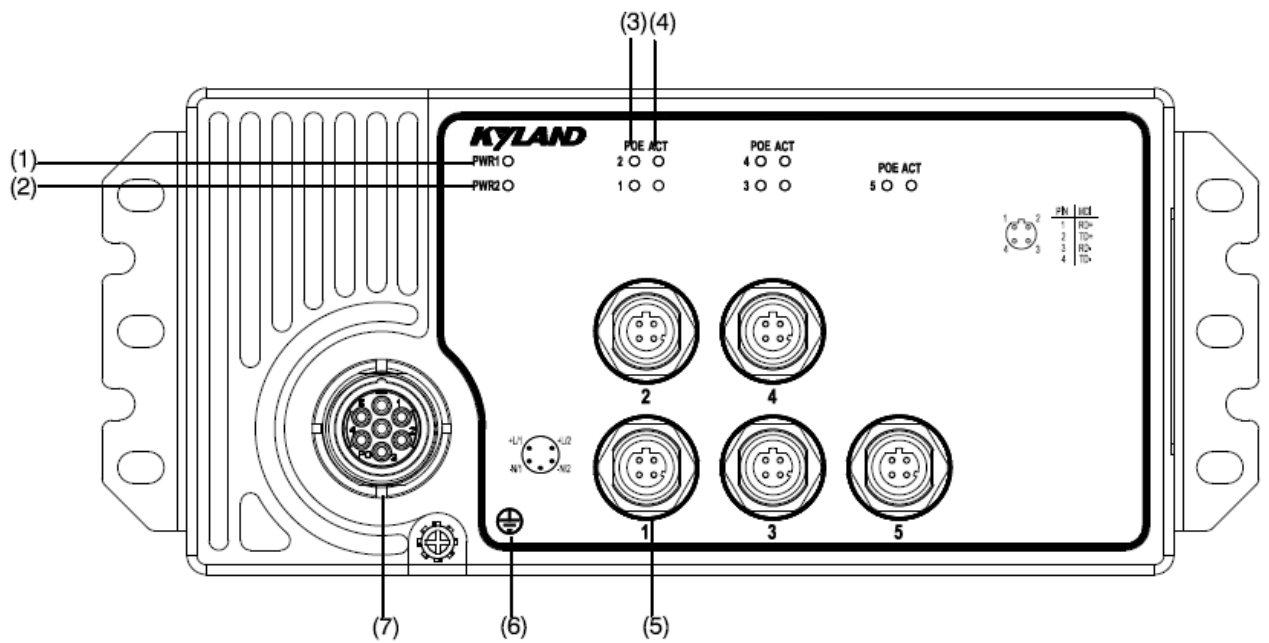

- Aquam8S Front Panel

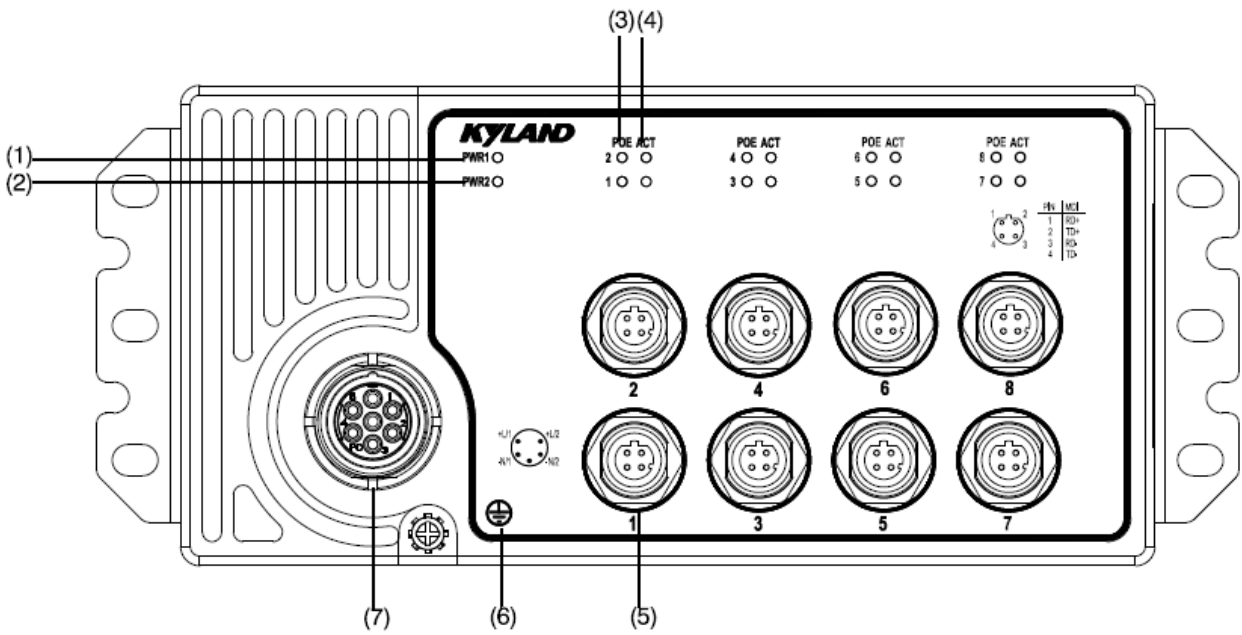

● Aquam9S Front Panel

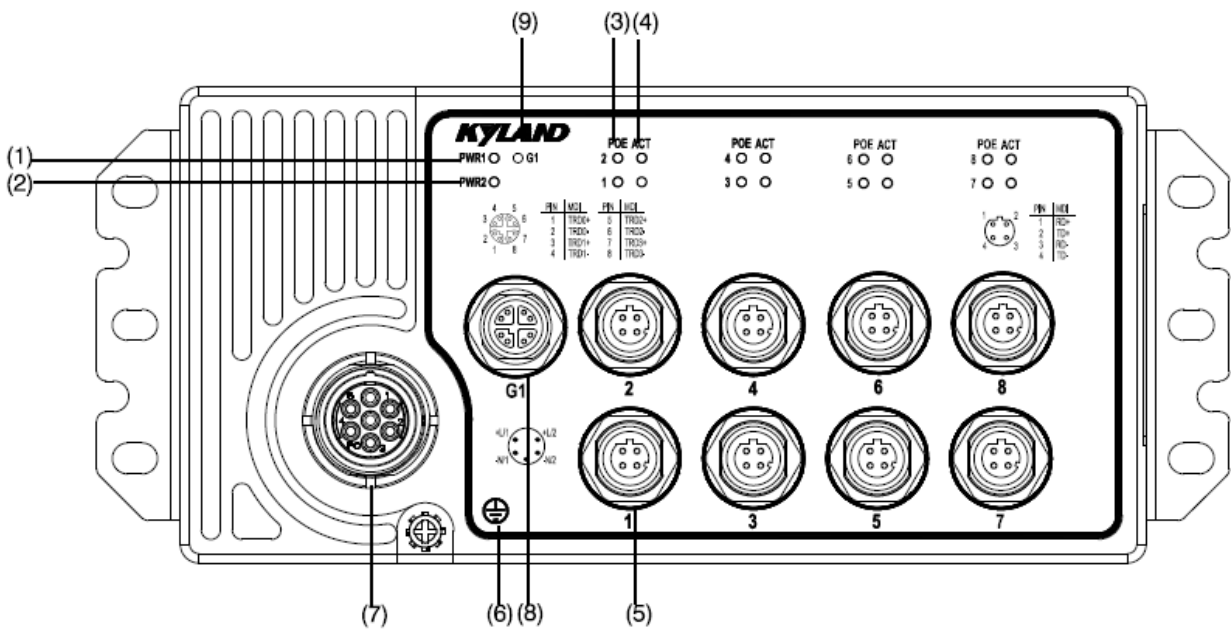

Figure 1 Front Panel

- (1) Power 1 LED
- (2) Power 2 LED
- (3) 10/100Base-T(X) Ethernet Port POE LED
- (4) 10/100Base-T(X) Ethernet port connection status LED
- (5) 10/100Base-T(X) POE Ethernet port

- (6) Grounding screw
- (7) Power port
- (8) 10/100/1000Base-T(X) Ethernet port
- (9) 10/100/1000Base-T(X) Ethernet port connection status LED

3 Mounting

3.1 Dimension Drawing

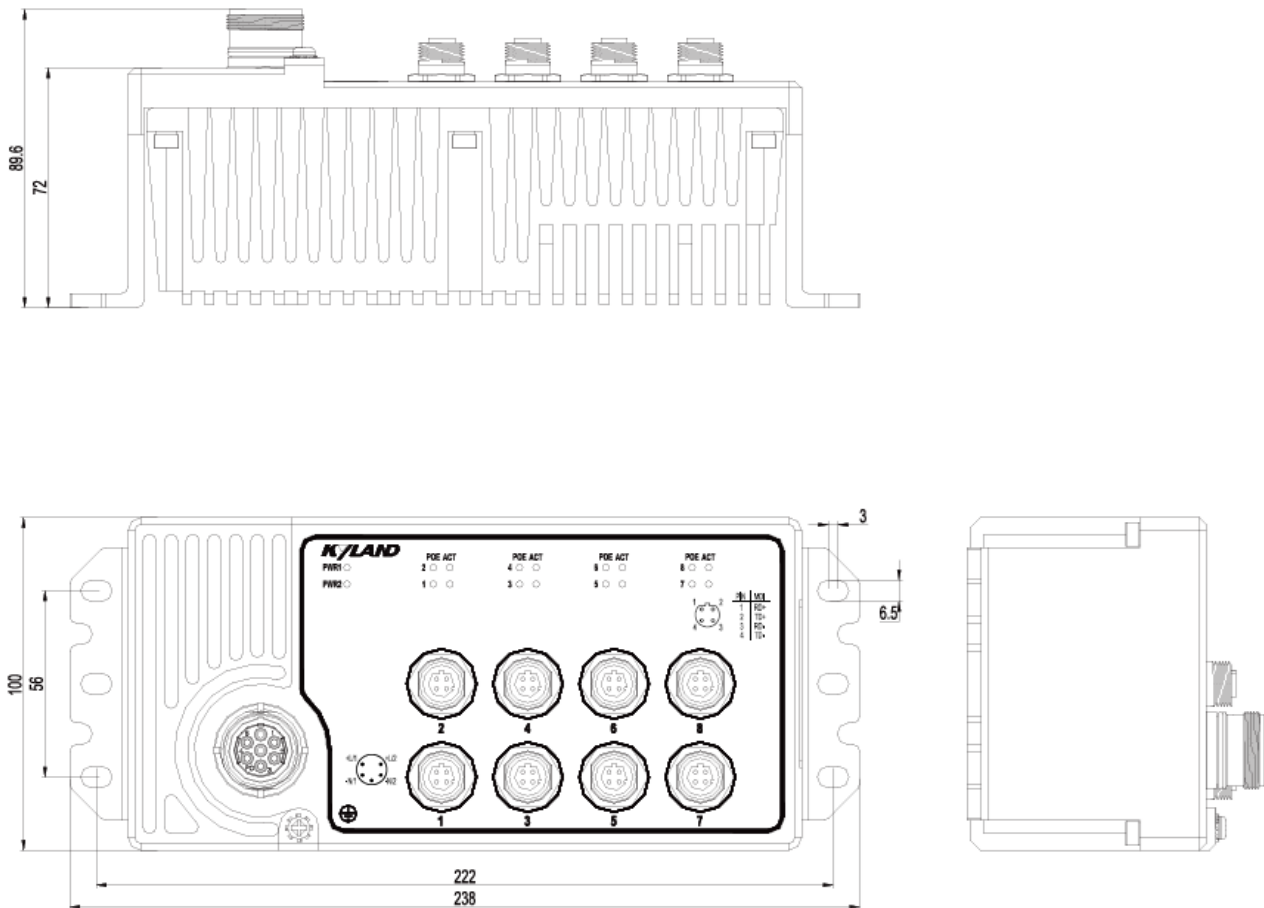

Figure 2 Dimensions (unit: mm)



Caution:

- As part of the heat dissipation system, the switch housing becomes hot during operation. Please use caution when coming in contact and avoid covering the switch housing when the switch is running.
- The figures in this manual are only for reference.

3.2 Mounting Modes and Steps

The series devices support panel mounting, and should be installed in the assembled cabinet that is “open type”. Before installation, make sure that the following requirements are

met.

- 1) Environment: temperature (-40°C to 70°C), ambient relative humidity (5% to 95%, non-condensing).
- 2) Power requirement: The power input is within the voltage range of the switch.
- 3) Grounding resistance: <math><5\Omega</math>
- 4) No direct sunlight, distant from heat source and areas with strong electromagnetic interference.
- 5) Devices are to be installed in an authority certified enclosure or even higher cabinet and accessible only by the use of a tool.
- 6) Devices should be installed and accessed by service personnel or users who have been instructed about the reasons for the restrictions applied to the location and about any precautions that shall be taken.

- Mounting

Step 1: Select the mounting position (on a wall or inner wall of a cabinet) for the device and guarantee adequate space and heat dissipation (Dimensions (WxHxD): 238mmx100mmx72mm).

Step 2: Punch six holes in the selected position according to the dimensions of the device. Put the screw holes of device in alignment with the corresponding punched holes. Then use six screws to secure the device to the wall or inner wall of a cabinet.

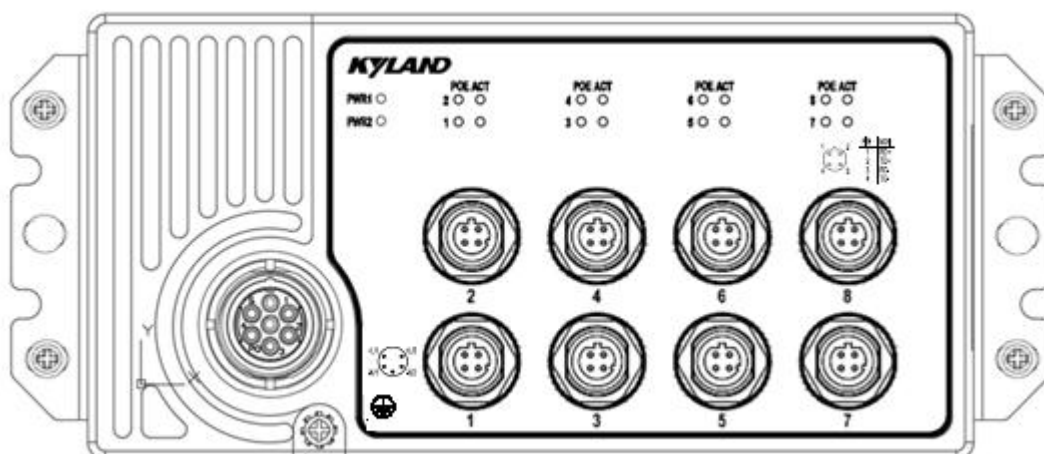

Figure 3 Panel Mounting

- Dismounting

Loosen the screws with a screwdriver, remove the screws and device from the wall or inner wall of a cabinet to complete dismounting.

**Caution:**

Cut off the power and disconnect all cables before mounting, dismounting or moving the equipment.

4 Connection

4.1 10/100Base-T(X) Ethernet Port

4.1.1 Functions

- Data Transmission

10/100Base-T(X) Ethernet port is equipped with M12 connector, which is dustproof, waterproof, and anti-vibration. The port is self-adaptive. It can automatically configure itself to work in 10M or 100M state, full or half duplex mode. The port can also adapt to MDI or MDI-X connection automatically. You can connect the port to a terminal or network device with a straight-through or cross-over cable.

- POE

Serving as the Power Sourcing Equipment (PSE), the switches can provide power supply for PDs through 10/100Base-T(X) Ethernet ports. The 10/100Base-T(X) Ethernet ports support IEEE802.3at (compatible with IEEE802.3af) POE output. The entire PSE is capable of providing a Maximum of 80W feed.

1. POE Definition

POE indicates that the device can provide power supply for PDs through Ethernet ports. The device supports a maximum distance of 100m for power supply.

2. POE Power Supply

The device supports data wires to provide power supply for PDs.

4.1.2 Pin Definitions and Wiring Sequence

- Pin Definition

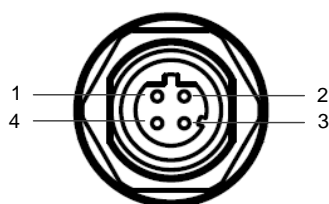

Figure 4 M12 Port (female)

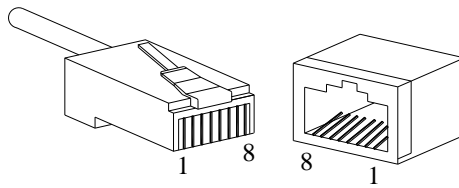



Figure 5 RJ45 Port

You can use an M12-M12 or M12-RJ45 cable to connect the port for communication. The preceding figures show the pin numbers of an M12 port and an RJ45 port. For pin definitions, see the following table.

Table 2 Pin Definitions of M12/RJ45 Port

Pin	MDI-X Signal	MDI Signal	POE
M12 Port			
1	Receive Data+ (RD+)	Transmit Data+ (TD+)	V+
2	Transmit Data+ (TD+)	Receive Data+ (RD+)	V-
3	Receive Data- (RD-)	Transmit Data- (TD-)	V+
4	Transmit Data- (TD-)	Receive Data- (RD-)	V-
RJ45 Port			
1	Receive Data+ (RD+)	Transmit Data+ (TD+)	--
2	Receive Data- (RD-)	Transmit Data- (TD-)	--
3	Transmit Data+ (TD+)	Receive Data+ (RD+)	--
6	Transmit Data- (TD-)	Receive Data- (RD-)	--
4, 5, 7, 8	Unused	Unused	--
 Note: "+" and "-" indicate level polarities.			

- Wiring Sequence

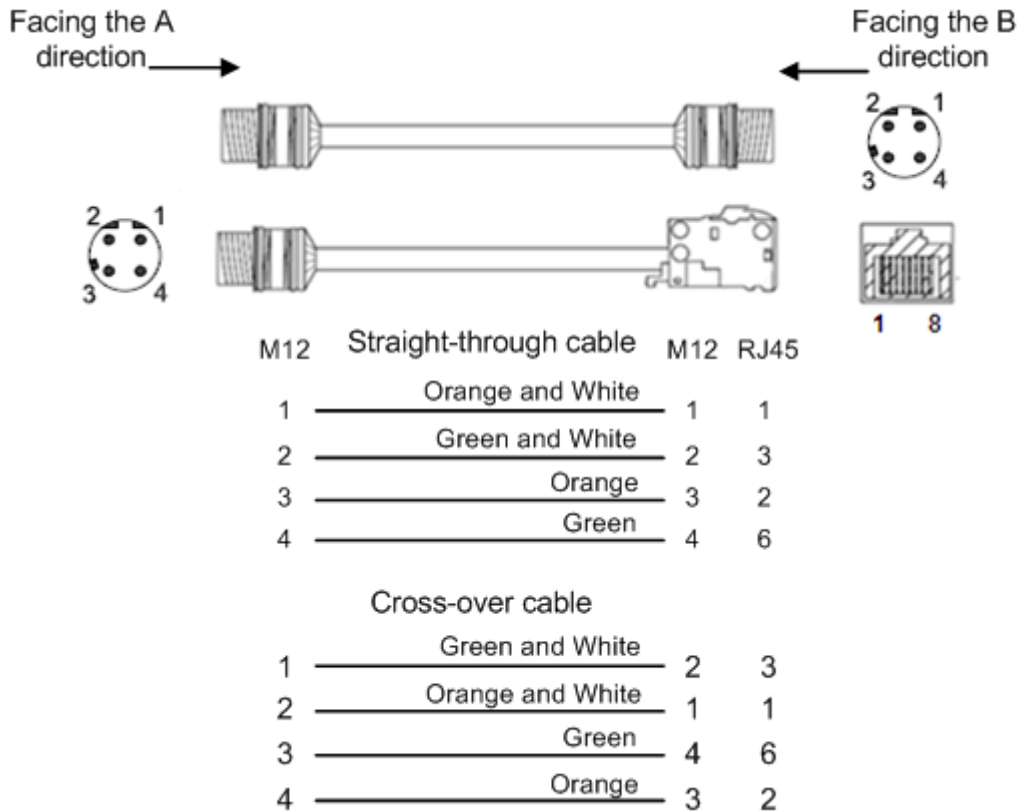

Figure 6 Connection Using Straight-through/Cross-over Cable



Note:

- The color of the cable for RJ45 connector meets the 568B standard: 1-orange and white, 2-orange, 3-green and white, 4-blue, 5-blue and white, 6-green, 7-brown and white, and 8-brown.
- The 1 and 3, 2 and 4 pins on the M12 interface are differentiated signal pins in pairs. The orange-and-white and orange pair, green-and-white and green pair, blue-and-white and blue pair, and brown-and-white and brown pair in twist pair cables must be used in correct pairs while being connected with the signal pins. For example, the above figure, the orange-and-white and orange and green-and-white and green pairs are used.
- POE ports will not deliver any power for a certain time when a 10ms interruption occurs on the power input. A suggested workaround is to connect a UPS to prevent power interruption of the PSE.

4.2 10/100/1000Base-T(X) Ethernet Port

10/100/1000Base-T(X) Ethernet port is equipped with M12 connector, which is dustproof, waterproof, and anti-vibration. The port is self-adaptive. It can automatically configure itself to work in 10M or 100M state, full or half duplex mode. The port can also adapt to MDI or MDI-X connection automatically. You can connect the port to a terminal or network device with a straight-through or cross-over cable.

- Pin Definition

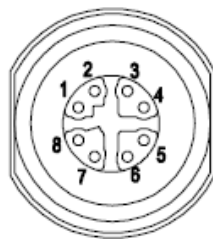

Figure 7 M12 Port (male)

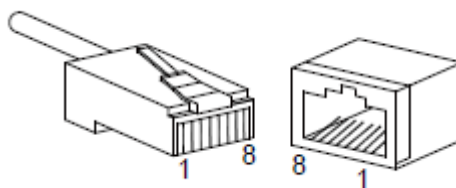



Figure 8 RJ45 Port

You can use an M12-M12 or M12-RJ45 cable to connect the port for communication. The preceding figures show the pin numbers of an M12 port and an RJ45 port. For pin definitions, see the following table.

Table 3 Pin Definitions of M12/RJ45 Port

Pin	MDI-X Signal	MDI Signal
M12 Port		
1	Transmit/Receive Data (TRD1+)	Transmit/Receive Data (TRD0+)
2	Transmit/Receive Data (TRD1-)	Transmit/Receive Data (TRD0-)
3	Transmit/Receive Data (TRD0+)	Transmit/Receive Data (TRD1+)

4	Transmit/Receive Data (TRD0-)	Transmit/Receive Data (TRD1-)
5	Transmit/Receive Data (TRD3+)	Transmit/Receive Data (TRD2+)
6	Transmit/Receive Data (TRD3-)	Transmit/Receive Data (TRD2-)
7	Transmit/Receive Data (TRD2+)	Transmit/Receive Data (TRD3+)
8	Transmit/Receive Data (TRD2-)	Transmit/Receive Data (TRD3-)
RJ45 Port		
1	Transmit/Receive Data (TRD1+)	Transmit/Receive Data (TRD0+)
2	Transmit/Receive Data (TRD1-)	Transmit/Receive Data (TRD0-)
3	Transmit/Receive Data (TRD0+)	Transmit/Receive Data (TRD1+)
4	Transmit/Receive Data (TRD3+)	Transmit/Receive Data (TRD2+)
5	Transmit/Receive Data (TRD3-)	Transmit/Receive Data (TRD2-)
6	Transmit/Receive Data (TRD0-)	Transmit/Receive Data (TRD1-)
7	Transmit/Receive Data (TRD2+)	Transmit/Receive Data (TRD3+)
8	Transmit/Receive Data (TRD2-)	Transmit/Receive Data (TRD3-)
 <p>Note: "+" and "-" indicate level polarities.</p>		

- Wiring Sequence

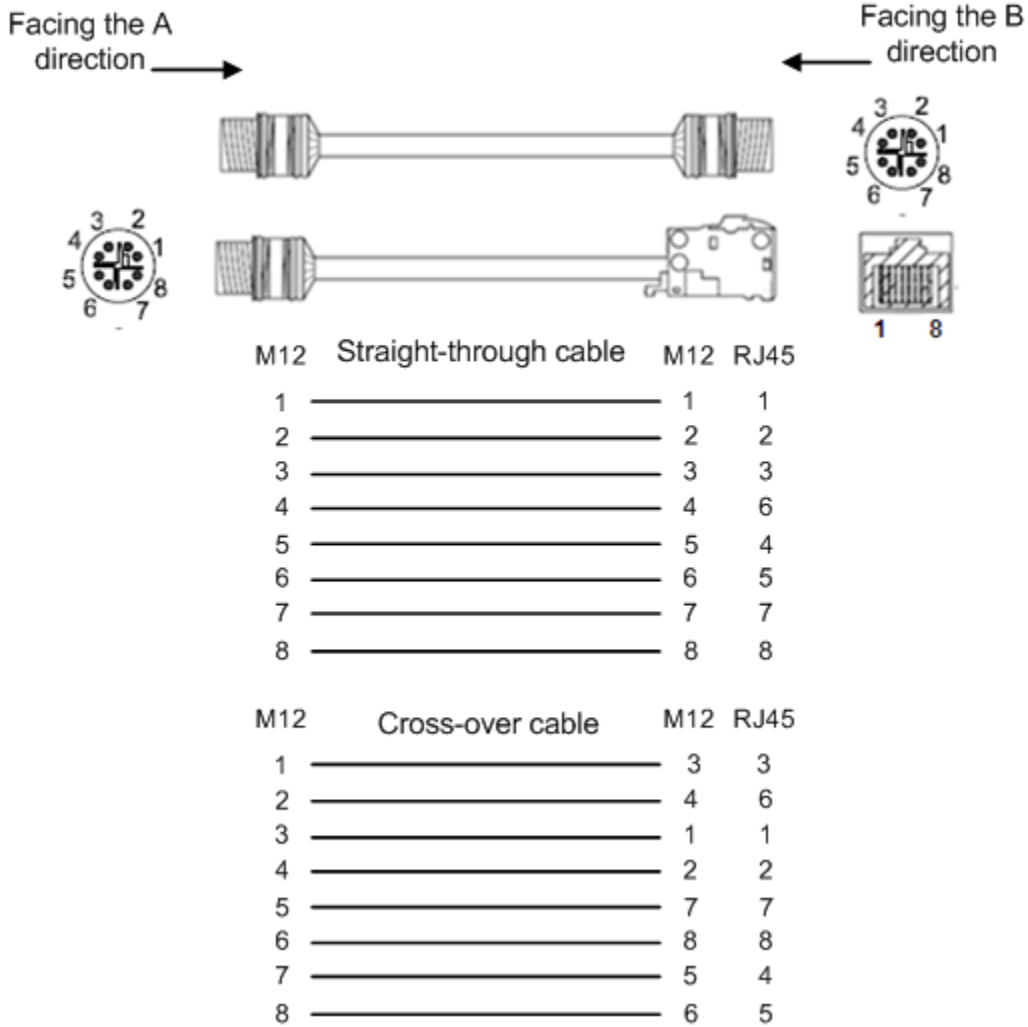

Figure 9 Connection Using Straight-through/Cross-over Cable



Note:

The color of the cable for RJ45 connector meets the 568B standard: 1-orange and white, 2-orange, 3-green and white, 4-blue, 5-blue and white, 6-green, 7-brown and white, and 8-brown.

4.3 Grounding

Grounding protects the device from lightning and interference. Therefore, you must ground the device properly. You need to ground the device before it is powered on and disconnect the grounding cable after the device is powered off. There is a grounding screw (see Figure 1) on the front panel of the device. The screw is for chassis grounding. After crimping one end of the grounding cable to a cold pressed terminal, secure the end of the grounding cable

to the grounding screw and firmly connect the other end to ground.



Note:

- Cross-sectional area of the chassis grounding cable $>2.5\text{mm}^2$; Grounding resistance $<5\Omega$.
- Earth line should be less than 3m.

4.4 Power port

There is a power port on the front panel of the device. You need to connect the power cable to the power port to provide power to the device. Power port is equipped with 5-pin M23 connector, which is dustproof, waterproof, and anti-vibration. The device supports redundant power input, when one power input is faulty, the device can continue operating properly, thereby improving network reliability.



Note:

$0.75\text{mm}^2 < \text{Cross-sectional area of the power cable} < 2.5\text{mm}^2$; grounding resistance $< 5\Omega$.

- Pin Definition

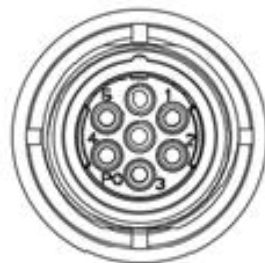

Figure 10 Power Port (male)

Table 4 Pin Definitions of Power Port

Pin	DC Wiring Definition
1	PWR2: +
2	PWR: -
3	PWR: -
4	PWR: -
5	PWR1: +

- Wiring and Mounting

Step 1: Ground the device properly according to section 4.2.

Step 2: Insert one end of the power cable into the M23 connector firmly.

Step 3: Insert the M23 connector with the connected cable into the power port on the device.

Step 4: Connect the other end of the power cable to an external power supply system according to the power supply requirements of the device. View the status of the power LED.

If the LED is on, the power is connected properly.

**Caution:**

Before connecting the device to power supply, make sure that the power input meets the power requirement. If connected to an incorrect power input, the device may be damaged.

**Warning:**

- Do not touch any exposed conducting wire, terminal, or component with a voltage warning sign, because it may cause personal injury.
 - Do not remove any part or plug in or out any connector when the device is powered on.
-

5 LEDs

Table 5 Front Panel LEDs

LED	State	Description
Power 1 LED-PWR1	On	The power 1 is connected and operates properly.
	Off	The power 1 is not connected or operates abnormally.
Power 2 LED-PWR2	On	The power 2 is connected and operates properly.
	Off	The power 2 is not connected or operates abnormally.
Ethernet port connection status LED	On	Effective port connection
	Blinking	Ongoing network activities
	Off	No effective port connection
Ethernet port POE LED-POE	On	The POE port provides power supply normally
	Blinking	The POE port provides power supply abnormally
	Off	The POE port provides no power supply

6 Basic Features and Specifications

Power Requirements

Power Identifier	Rated Voltage Range	Maximum Voltage Range
WV	24-110VDC	16.8-154VDC
Terminal Block	5-pin M23 connector	

Rated Power Consumption

Rated Power Consumption	Without PD: 0.4A @24VDC (MAX) With 80W PD: 7.0A@24VDC (MAX)
-------------------------	--

Physical Characteristics

Housing	Metal, fanless
Installation	Panel mounting
Dimensions(WxHxD)	238mm×100mm×72mm (excluding connectors)
Weight:	1.91Kg (Max)
Fastening Cover Version Torque	0.3 N·M
Fastening Connector Nut Torque	1.3 N·M

Environmental Limits

Ambient Temperature	-40℃ ~ +70℃
Storage Temperature	-40℃ ~ +85℃
Ambient Relative Humidity	5% ~ 95% (non-condensing)

MTBF

MTBF	2107371h
------	----------

Warranty

Warranty	Five years
----------	------------
